



## **Application Note**

### **AN\_193**

# **Vinculum-II SPI Master to USB HID Class Host Bridge**

**Version 1.0**

**Issue Date: 2011-11-11**

This application note forms part of a series of application notes detailing the new simplified ROM images for VNC2. It will detail the implementation and use of a VNC2 ROM file for bridging a SPI Master interface to hosting a HID class USB device.

Use of FTDI devices in life support and/or safety applications is entirely at the user's risk, and the user agrees to defend, indemnify and hold harmless FTDI from any and all damages, claims, suits or expense resulting from such use.

**Future Technology Devices International Limited (FTDI)**

Unit 1, 2 Seaward Place, Glasgow G41 1HH, United Kingdom

Tel.: +44 (0) 141 429 2777 Fax: + 44 (0) 141 429 2758

Web Site: <http://ftdichip.com>

Copyright © 2011 Future Technology Devices International Limited

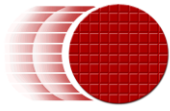

## **Table of Contents**

1	Introduction .....	2
1.1	Overview .....	2
2	Using the Sample Code .....	3
3	Default Pin-Out .....	4
4	Building and Loading the Firmware into the VNC2.....	6
4.1	Build .....	6
4.2	Load.....	6
4.3	Loading with FT_Prog.....	7
5	Source Code for the VNC2 Application .....	8
5.1	HIDSpiM.C .....	8
5.1.1	main() .....	8
5.1.2	lomux_setup().....	8
5.1.3	Open drivers/close drivers.....	8
5.1.4	USB_Host_Connect_state .....	8
5.1.5	Setup .....	9
5.1.6	Firmware .....	9
6	Contact Information.....	10
	Appendix A – References .....	11
	Document References.....	11
	Acronyms and Abbreviations .....	11
	Appendix B – List of Tables & Figures .....	12
	List of Tables .....	12
	List of Figures .....	12
	Appendix C – Revision History .....	13



## 1 Introduction

FTDI have introduced a new suite of simplified “bridging” ROM files to allow for fast interconnect between differing interfaces. These ROM images (and sample code) are targeted at those users who would like to implement VNC2 into a design without creating their own firmware.

As well as providing the source code for users wishing to tweak setup parameters the default project will be supplied as a precompiled ROM file ready for installation into the VNC2.

This application note forms part of a series of application notes detailing the new simplified ROM images for VNC2. This document will detail the implementation and use of a VNC2 ROM file for bridging a SPI Master interface to hosting a Human Interface Device (HID) class device on a USB port. This particular project may be used in 32, 48 or 64 pin packages.

For users not intending to edit the code in any way the precompiled code may be loaded over the UART interface with [FT\\_PROG](#) as an alternative to using the IDE. Links for the project file HIDSpiM.vproj and the precompiled ROM HIDSpiM.rom file may be found at the end of the document in Appendix A.

### 1.1 Overview

VNC2 is the second of FTDI’s Vinculum family of embedded dual USB host controller devices. The VNC2 device provides USB Host interfacing capability for a variety of different USB device classes including support for BOMS (bulk only mass storage), Printer and HID (human interface devices). For mass storage devices such as USB Flash drives, VNC2 transparently handles the FAT file structure.

Communication with non USB devices, such as a low cost microcontroller, is accomplished via UART, SPI or parallel FIFO interfaces. VNC2 provides a new, cost effective solution for providing USB Host capability into products that previously did not have the hardware resources available.

VNC2 allows customers to develop their own firmware using the Vinculum II software development tool suite. These development tools provide compiler, assembler, linker and debugger tools complete within an integrated development environment (IDE).

The Vinculum-II VNC2 family of devices are available in Pb-free (RoHS compliant) 32-lead LQFP, 32-lead QFN, 48-lead LQFP, 48-lead QFN, 64-Lead LQFP and 64-lead QFN packages For more information on the ICs refer to <http://www.ftdichip.com/Products/ICs/VNC2.htm>.

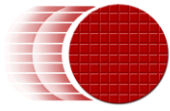

## 2 Using the Sample Code

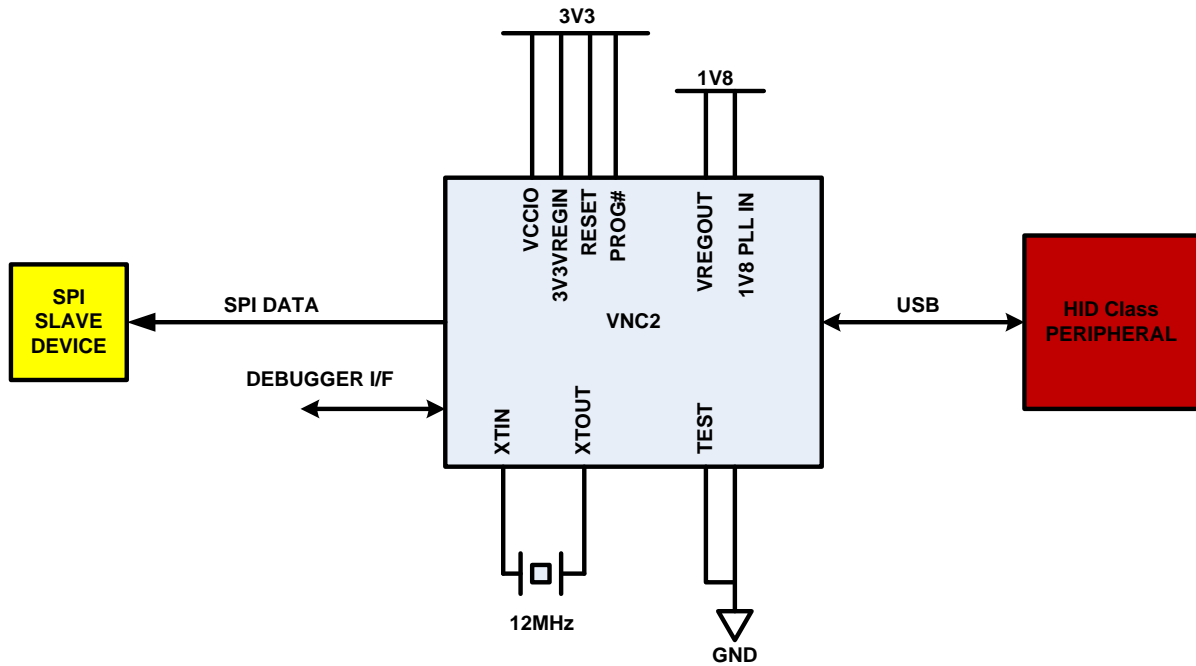
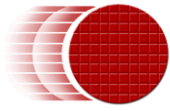

**Figure 2.1 Connecting the Demo**

When the VNC2 is programmed, the user simply passes data from the HID class device connected to the USB port 1 of the VNC2. The VNC2 will process this data to pass it out to SPI Master port of the chip.

There are no additional commands required; it is a simple data bridge.

The project default set the SPI Master to SPI Mode 0 with a 3MHz Clk and most significant data bit first.



### 3 Default Pin-Out

The VNC2 can assign the same signal to a variety of pins. The default pins used for this ROM image are shown in **Error! Reference source not found.**

Signal	32-pin pkg	48-pin pkg	64-pin pkg	Description
GND	1, 16, 19, 27	1, 24, 27, 39	1, 30, 35, 53	Device ground supply pins
3V3 VREGIN	2	2	2	+3.3VDC supply to the regulator
1V8 VCC PLL IN	3	3	3	+1.8VDC supply to internal clock multiplier Requires 100nF decoupling capacitor close to pin
GND PLL	6	6	6	Device analog ground supply for internal clock multiplier
VREG OUT	7	7*	7	+1.8VDC output from regulator to device core *Not used on 48-pin LQFP package
VCCIO	13, 22, 28	17, 30, 40	21, 38, 54	+3.3VDC supply to I/O interface pins (IOBUS) VCCIO must be connected for proper operation
XTIN	4	4	4	Input to 12MHz Oscillator Connect 12MHz crystal across pins 4 and 5 with proper loading capacitance
XTOUT	5	5	5	Output from 12MHz Oscillator Connect 12MHz crystal across pins 4 and 5 with proper loading capacitance
TEST	8	8	8	Test – Must be connected to GND for normal operation
RESET#	10	9	9	Can be used by an external device to reset VNC2
PROG#	9	10	10	Asserting PROG# enables program mode
DEBUGGER I/F	11	11	11	I/O for programming and in-circuit debugging
USB DP1	17	25	33	USB Port 1 Data Plus
USB DM1	18	26	34	USB Port 1 Data Minus
SPI_M_CLK	29	20	61	SPI Clock output
SPI_M_MOSI	12	21	62	SPI data output
SPI_M_MISO	14	22	63	SPI data input
SPI_M_SS#	15	23	64	SPI slave select

**Table 3.1 VNC2 Pin-Out**

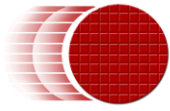

Designers wanting to customize the design should refer to the iomux.c file for changing pin-out options.

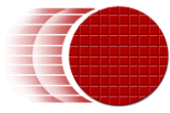

## 4 Building and Loading the Firmware into the VNC2

Everything can be controlled by the IDE. To access the application simply use the Project -> Open tab to browse to the HIDSpiM.vproj file for your project.

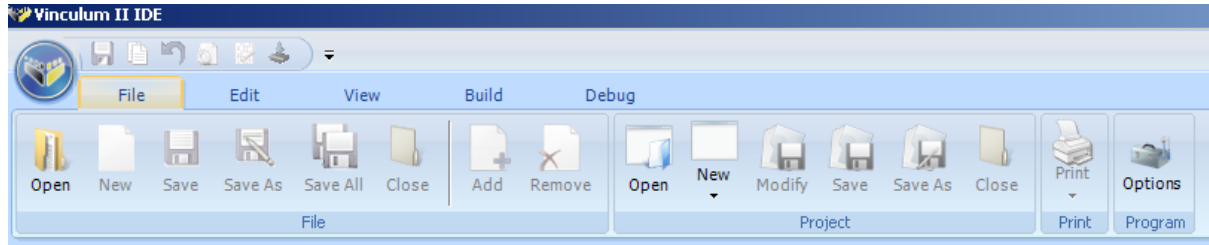
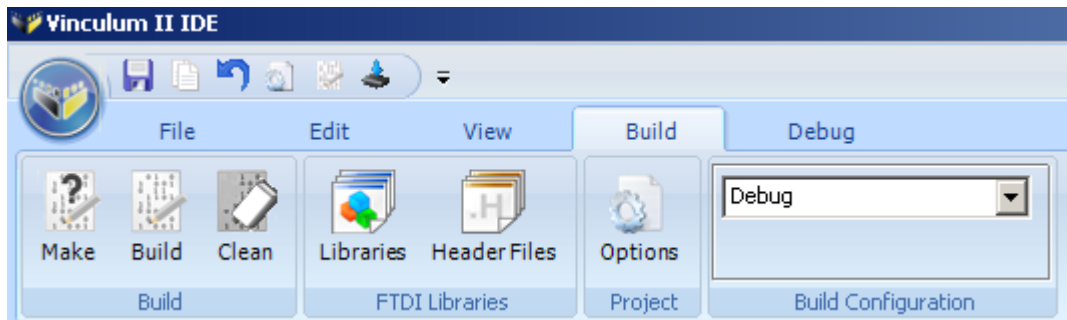

**Figure 4.1 Vinculum-II Project Open Button**

### 4.1 Build

This step is only necessary if you are not using the precompiled version of the ROM. Otherwise proceed to loading the ROM file.

To build the application you simply press the Build button on the IDE ribbon bar under the build tab.



**Figure 4.2 Vinculum-II IDE Build Button**

### 4.2 Load

Loading the code is equally simple. Just click on the "Flash" button on the ribbon bar under the debug tab. The Flash button will automatically pick up the Rom file in your project but for reference the filename is HIDSpiM.ROM.

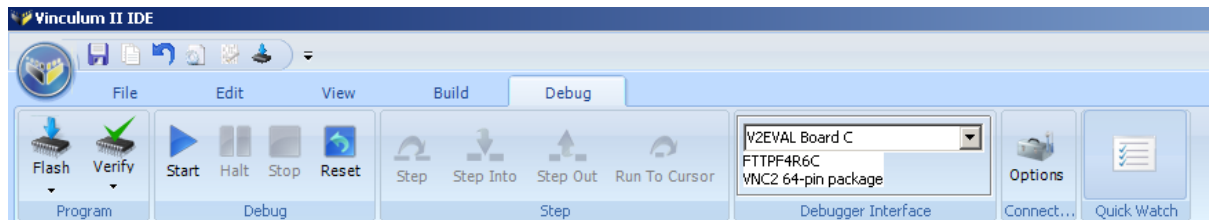

**Figure 4.3 Vinculum-II IDE Flash Button**

Note the Debugger Interface is listed as V2EVAL Board C. It is important that this box shows a device is connected before attempting to flash a device.



### 4.3 Loading with FT\_Prog

If the precompiled ROM file meets all the requirements of the end design then the IDE and source code are not required. The precompiled HIDSpm.ROM file may be loaded into the VNC2 with FT\_PROG over the UART interface.

FT\_Prog is used to program the VNC2 with a ROM file. FT\_Prog is available from the FTDI website utilities page (version 1.12 or later supports VNC2).

- Select the flash ROM tab at the top of the window.
- Select VNC2 from the pull down tab.
- Select D2xx or VCP interface (either will work).
- Select the location where the ROM file resides.
- Press the program button.
- Perform a hard reset (power cycle) prior to running the firmware.

Figure 4.4 is an example of programming the VNC2 Evaluation board revision 2 with the V2DAP firmware.

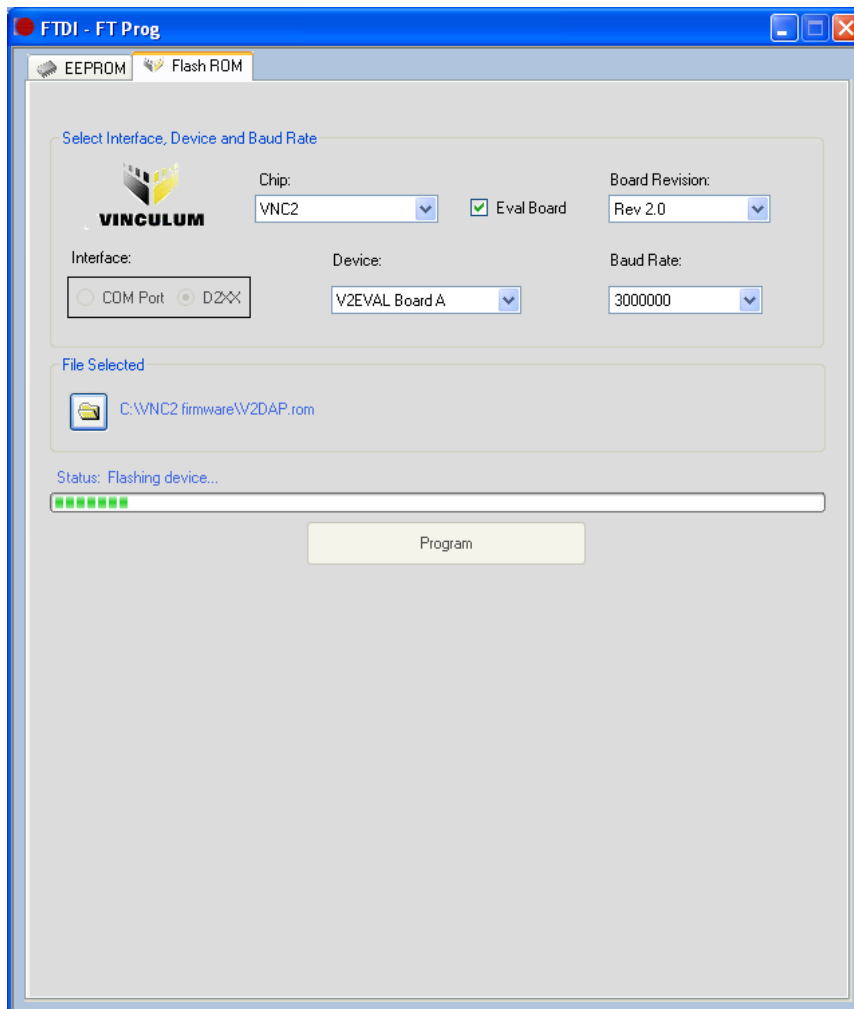
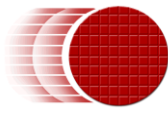

**Figure 4.4 FT\_Prog Programming Utility**

For more information on loading ROM files onto a VNC2 device refer to:

[http://www.ftdichip.com/Support/Documents/AppNotes/AN\\_159%20Vinculum-II%20Firmware%20Flash%20Programming.pdf](http://www.ftdichip.com/Support/Documents/AppNotes/AN_159%20Vinculum-II%20Firmware%20Flash%20Programming.pdf)





## 5 Source Code for the VNC2 Application

This section is aimed at those wanting to learn about coding VNC2 devices or modify the existing project.

All VNC2 application firmware follows a similar format and most of the code can be “written” using the IDE application wizard.

The basic steps are:

1. Initialise device drivers
2. Define pin-outs
3. Open ports to be used
4. Configure ports to be used
5. Read/write data
6. Close ports

The VNC2 source code for this project can be viewed in appendix A and is available to [download with the toolchain](#).

### 5.1 HIDSpiM.C

HIDSpiM.c is the main firmware file. This file is split into multiple functions.

```
void main();  
void iomux_setup(void);  
void open_drivers(void);  
void close_drivers(void);  
void setup(void);  
unsigned char usbhost_connect_state(VOS_HANDLE hUSB)  
void firmware(void)
```

#### 5.1.1 main()

Main is where the application starts. It defines the VNC2 core clock speed, loads the drivers to be used and creates the threads to be used in the application. At the very end of main is the call

```
vos_start_scheduler();
```

After this call there can be no further configuration of the device.

#### 5.1.2 Iomux\_setup()

Iomux\_setup actually refers to the other file in the project, HIDSpiM\_iomux.c and is used to define the VNC2 pin-out. Most functions can be programmed to appear on different pins. The notable exceptions are power, GND and the USB ports.

#### 5.1.3 Open drivers/close drivers

The open drivers function call will provide a handle to each hardware block used in the project and this handle can be used by subsequent commands to control the hardware. Close drivers closes the handle at the end of the project.

#### 5.1.4 USB\_Host\_Connect\_state

USB\_Host\_Connect\_State is a function to check if anything is connected to the USB host.

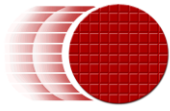

### **5.1.5 Setup**

This function will configure the SPI Master port as SPI mode 0, with a 3MHz clock and most significant data bit first.

### **5.1.6 Firmware**

This function will configure the the USB host port to support HID class devices and read data from this USB port to be written on the SPI Master port.

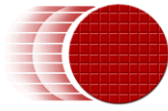

## 6 Contact Information

### Head Office – Glasgow, UK

Future Technology Devices International Limited  
Unit 1, 2 Seaward Place, Centurion Business Park  
Glasgow G41 1HH  
United Kingdom  
Tel: +44 (0) 141 429 2777  
Fax: +44 (0) 141 429 2758

E-mail (Sales) [sales1@ftdichip.com](mailto:sales1@ftdichip.com)  
E-mail (Support) [support1@ftdichip.com](mailto:support1@ftdichip.com)  
E-mail (General Enquiries) [admin1@ftdichip.com](mailto:admin1@ftdichip.com)

### Branch Office – Hillsboro, Oregon, USA

Future Technology Devices International Limited  
(USA)  
7235 NW Evergreen Parkway, Suite 600  
Hillsboro, OR 97123-5803  
USA  
Tel: +1 (503) 547 0988  
Fax: +1 (503) 547 0987

E-Mail (Sales) [us.sales@ftdichip.com](mailto:us.sales@ftdichip.com)  
E-Mail (Support) [us.support@ftdichip.com](mailto:us.support@ftdichip.com)  
E-Mail (General Enquiries) [us.admin@ftdichip.com](mailto:us.admin@ftdichip.com)

### Branch Office – Taipei, Taiwan

Future Technology Devices International Limited  
(Taiwan)  
2F, No. 516, Sec. 1, NeiHu Road  
Taipei 114  
Taiwan, R.O.C.  
Tel: +886 (0) 2 8791 3570  
Fax: +886 (0) 2 8791 3576

E-mail (Sales) [tw.sales1@ftdichip.com](mailto:tw.sales1@ftdichip.com)  
E-mail (Support) [tw.support1@ftdichip.com](mailto:tw.support1@ftdichip.com)  
E-mail (General Enquiries) [tw.admin1@ftdichip.com](mailto:tw.admin1@ftdichip.com)

### Branch Office – Shanghai, China

Future Technology Devices International Limited  
(China)  
Room 408, 317 Xianxia Road,  
Shanghai, 200051  
China  
Tel: +86 21 62351596  
Fax: +86 21 62351595

E-mail (Sales) [cn.sales@ftdichip.com](mailto:cn.sales@ftdichip.com)  
E-mail (Support) [cn.support@ftdichip.com](mailto:cn.support@ftdichip.com)  
E-mail (General Enquiries) [cn.admin@ftdichip.com](mailto:cn.admin@ftdichip.com)

### Web Site

<http://ftdichip.com>

System and equipment manufacturers and designers are responsible to ensure that their systems, and any Future Technology Devices International Ltd (FTDI) devices incorporated in their systems, meet all applicable safety, regulatory and system-level performance requirements. All application-related information in this document (including application descriptions, suggested FTDI devices and other materials) is provided for reference only. While FTDI has taken care to assure it is accurate, this information is subject to customer confirmation, and FTDI disclaims all liability for system designs and for any applications assistance provided by FTDI. Use of FTDI devices in life support and/or safety applications is entirely at the user's risk, and the user agrees to defend, indemnify and hold harmless FTDI from any and all damages, claims, suits or expense resulting from such use. This document is subject to change without notice. No freedom to use patents or other intellectual property rights is implied by the publication of this document. Neither the whole nor any part of the information contained in, or the product described in this document, may be adapted or reproduced in any material or electronic form without the prior written consent of the copyright holder. Future Technology Devices International Ltd, Unit 1, 2 Seaward Place, Centurion Business Park, Glasgow G41 1HH, United Kingdom. Scotland Registered Company Number: SC136640

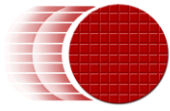

## Appendix A – References

### Document References

Application and Technical Notes available at  
<http://www.ftdichip.com/Support/Documents/AppNotes.htm>

[VNC2 Datasheet](#)

[V2-EVAL datasheet](#)

[Vinculum II Toolchain](#)

[AN\\_139 IO Mux explained](#)

[AN\\_151 Vinculum II User Guide](#)

[AN\\_159 Vinculum II Firmware Flash Programming.pdf](#)

Project source code download

<http://www.ftdichip.com/Firmware/Precompiled/HIDSpiM.zip>

Project precompiled ROM file download

<http://www.ftdichip.com/Firmware/Precompiled/HIDSpiM.ROM>

### Acronyms and Abbreviations

Terms	Description
SPI	Serial Peripheral Interface
UART	Universal Asynchronous Receiver Transmitter
USB	Universal Serial Bus
USB-IF	USB Implementers Forum

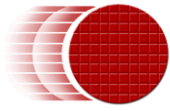

## **Appendix B – List of Tables & Figures**

### **List of Tables**

Table 3.1 VNC2 Pin-Out ..... 4

### **List of Figures**

Figure 2.1 Connecting the Demo ..... 3  
Figure 4.1 Vinculum-II Project Open Button ..... 6  
Figure 4.2 Vinculum-II IDE Build Button ..... 6  
Figure 4.3 Vinculum-II IDE Flash Button ..... 6  
Figure 4.4 FT\_Prog Programming Utility ..... 7

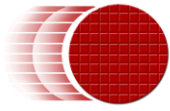

## Appendix C – Revision History

Document Title: AN\_193 Vinculum-II SPI Master to USB HID Class Host Bridge  
Document Reference No.: FT\_000537  
Clearance No.: FTDI# 234  
Product Page: <http://www.ftdichip.com/Products/ICs/VNC2.htm>  
Document Feedback: [Send Feedback](#)

Revision	Changes	Date
1.0	Initial Release	2011-11-14