



Application Note

AN_236

User Guide for FT312D Configuration Utility

Version 1.0

Issue Date: 2013-04-25

This application note explains how to program FT312D descriptor strings using a free FTDI utility, FT312D Configuration. The application communicates with the FT312D over USB via the FTDI USB to USB Null Modem cable

Use of FTDI devices in life support and/or safety applications is entirely at the user's risk, and the user agrees to defend, indemnify and hold FTDI harmless from any and all damages, claims, suits or expense resulting from such use.

Future Technology Devices International Limited (FTDI)

Unit 1, 2 Seaward Place, Glasgow G41 1HH, United Kingdom

Tel.: +44 (0) 141 429 2777 Fax: + 44 (0) 141 429 2758

Web Site: <http://ftdichip.com>

Copyright © 2012-2013 Future Technology Devices International Limited

Table of Contents

1	Introduction	2
1.1	Overview	2
1.2	Hardware Requirements.....	2
1.3	Software Requirements	3
2	Test Setup	4
2.1	Preparing the test PC	4
2.2	Preparing the hardware.....	4
3	Using the FT312D Configuration Utility	5
3.1	Test Setup Errors.....	10
3.2	User Defined descriptor size	11
4	FTDI Chip Contact Information	12
	Appendix A – References	13
	Document References.....	13
	Acronyms and Abbreviations	13
	Appendix B – List of Tables & Figures	14
	List of Tables	14
	List of Figures	14
	Appendix C – Revision History	15

1 Introduction

Android Open Accessory hardware is paired with applications running on the Android platform based on the descriptor strings the device sends to the Android. The FT312D allows for these strings to be modified such that the device may be used with multiple applications.

This application note describes the test setup and usage of the FT312D Configuration Utility for making these modifications.

The utility is intended for use in FT312D manufacturing environment to configure the descriptor strings. This utility is needed only if the default descriptor strings have to be changed.

FT312D Configuration application is downloadable from the FTDI website at http://www.ftdichip.com/Support/Utilities/FT312D_Configuration_V010000.zip

1.1 Overview

The [Figure 1.1](#) below shows the block diagram of the FT312D Configuration setup.

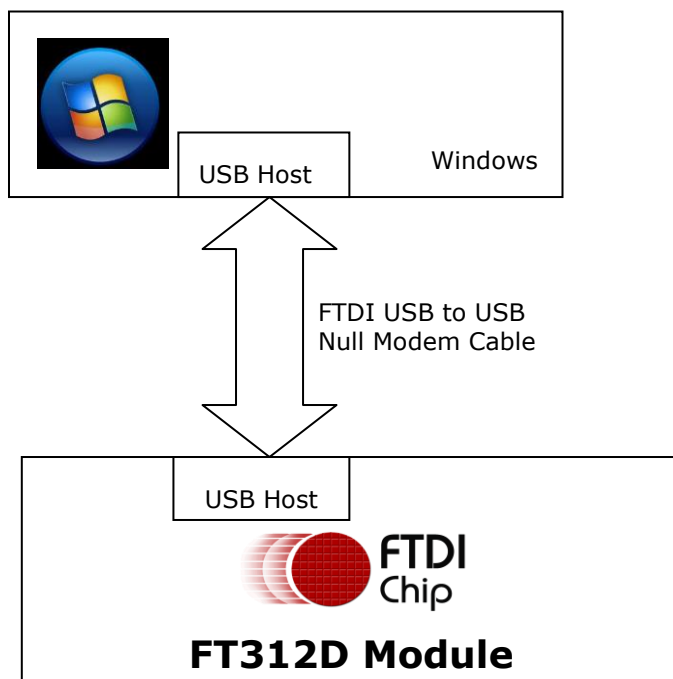

Figure 1.1: Block diagram of FT312D Configuration setup

1.2 Hardware Requirements

FTDI FT312D (may be mounted on the UMFT311EV or the customers own design).

FTDI USB to USB Null Modem Cable.

5V power supply.

Test PC running Window XP or later.

Note: Customers developing custom design should refer to Appendix A: document reference for FT311D Development Module.

1.3 Software Requirements

Operating system: Windows XP or later.

USB Serial Converter driver: Install the latest FTDI D2XX driver from www.ftdichip.com
<http://www.ftdichip.com/Drivers/D2XX.htm>

Framework: Microsoft .NET Framework 4 needs to be installed to run the test software

Application: FT312D_Configuration.exe and supporting files

2 Test Setup

2.1 Preparing the test PC

1. Download & install Microsoft .NET Framework 4 from the following website <http://www.microsoft.com/download/en/details.aspx?id=17851>
2. FT312D Configuration is downloadable from the FTDI website at http://www.ftdichip.com/Support/Utilities/FT312D_Configuration_V010000.zip
3. Copy the test software (FT312D_Configuration_V010000.zip) folder to a local hard drive.
4. Unzip them if the folders are compressed. For maximum compatibility, make sure that there are no non-English character in the path leading to the folders.

2.2 Preparing the hardware

The test setup is done with the following steps

1. Connect the FTDI USB to USB Null Modem cable to the PC and install the driver. This will happen automatically if connected to the internet.
2. Connect the free end of USB to USB Null Modem Cable to the FT312D Hardware via the USB Host port.
3. Power up the FT312D from a 5V supply.
4. The FT312D will now enumerate the Null Modem cable to complete the data link back to the PC.

Note:

FTDI USB to USB Null Modem cable is the only FTDI device connected to the test PC.

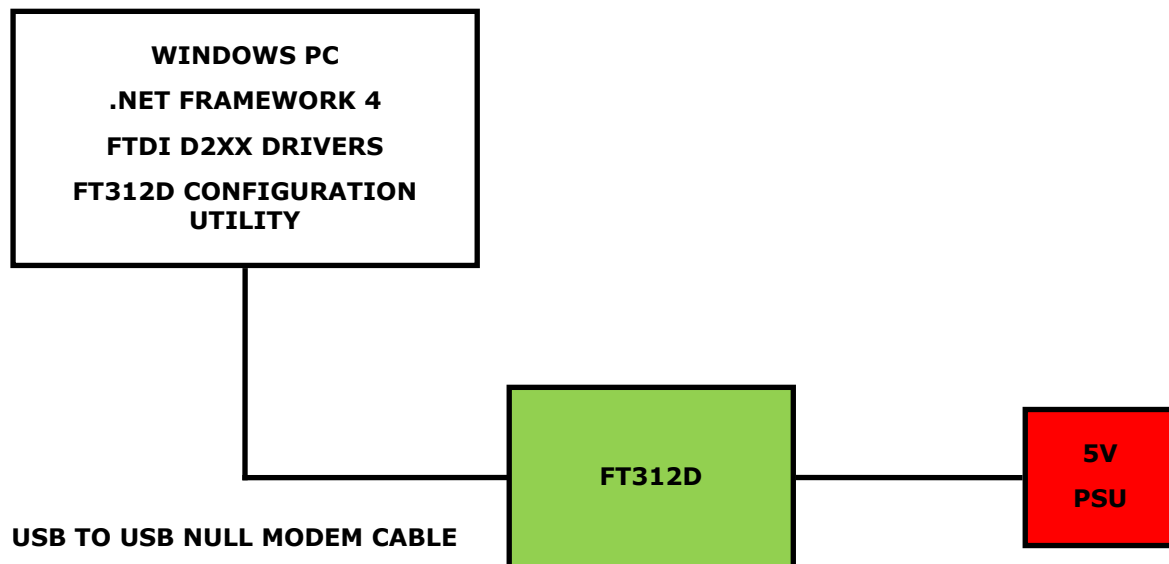

Figure 2.1: Completed FT312D Test Setup

The completed test setup is shown in the [Figure 2.1](#). The FT312D is powered from 5V.

3 Using the FT312D Configuration Utility

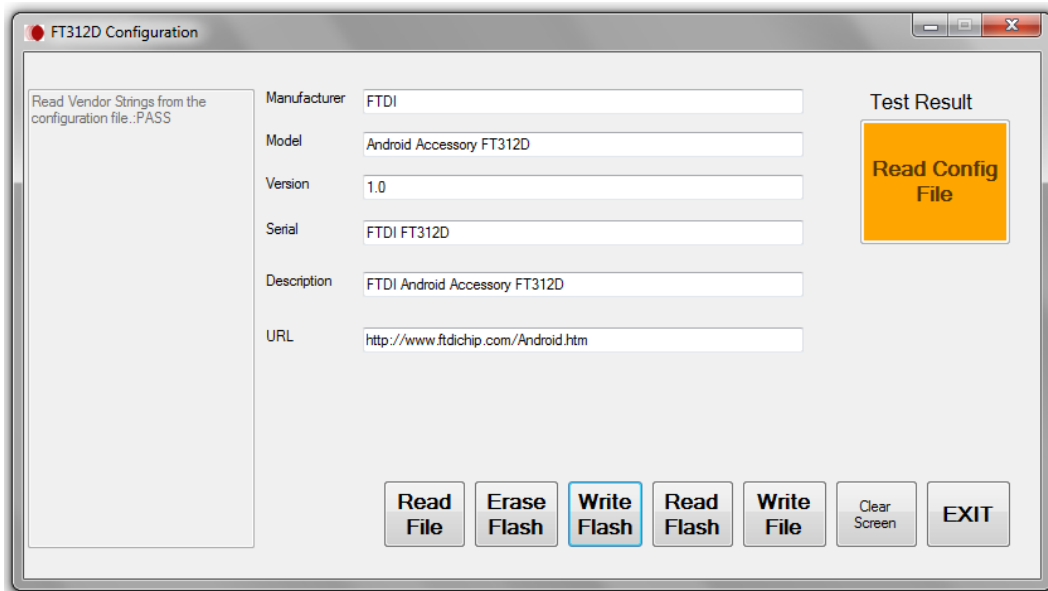

Figure 3.1: FT312D Configuration Utility

Note:

Only one instance of the FT312D Configuration application should be opened.

Run FT312D Configuration.exe. The software will start, opening a screen similar to the one shown in [Figure 3.1](#). The buttons may then be used to perform the following tasks:

Read File

Read File will load the configuration file into the GUI, filling in the values for the strings as shown in the [Figure 3.1](#). A default FT312DConfiguration.xml is present in the application folder. This may be updated with the Write File button.

Erase Flash

The descriptor strings that the user programs to the FT312D may be erased with the Erase Flash button. A device that is erased will still function with the default descriptor strings stored in the device. The utility also checks the setup and pops up a message if the setup is wrong.

The result is PASS if the erase is successful. The result is FAIL if the erase is failed.

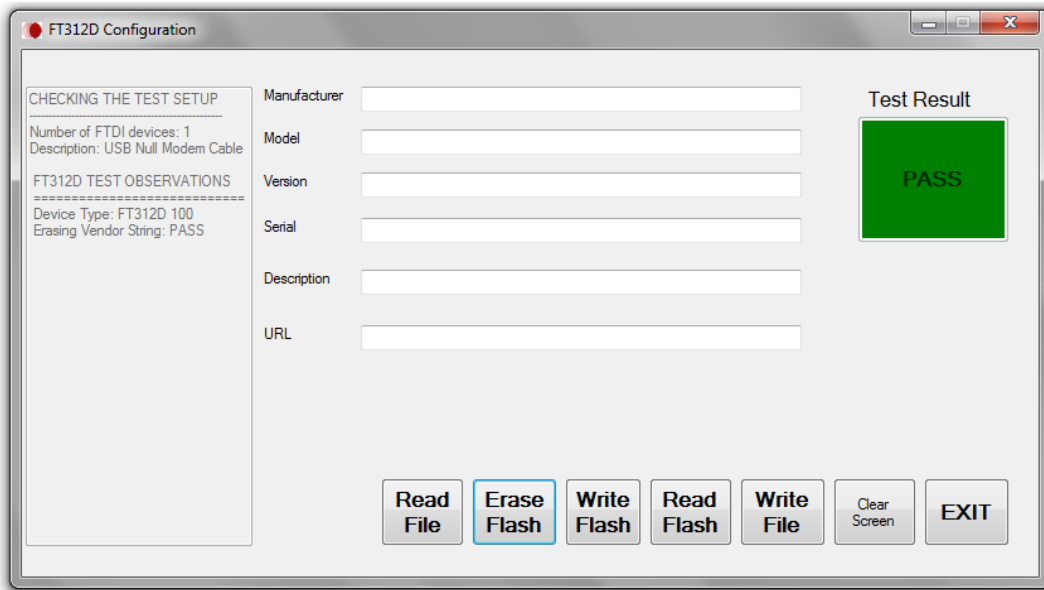

Figure 3.2: Erase Flash

Write Flash

Write Flash will store the descriptor strings displayed in the GUI to the FT312D.

The utility also checks the setup and pops up a message if the setup is wrong.

The result is PASS if the write is successful as shown in the [Figure 3.3](#). The result is FAIL if the write is failed as shown in the [Figure 3.4](#). The Write Flash failed because the descriptor strings in the GUI is not filled. All the descriptor string fields in the GUI has to be filled.

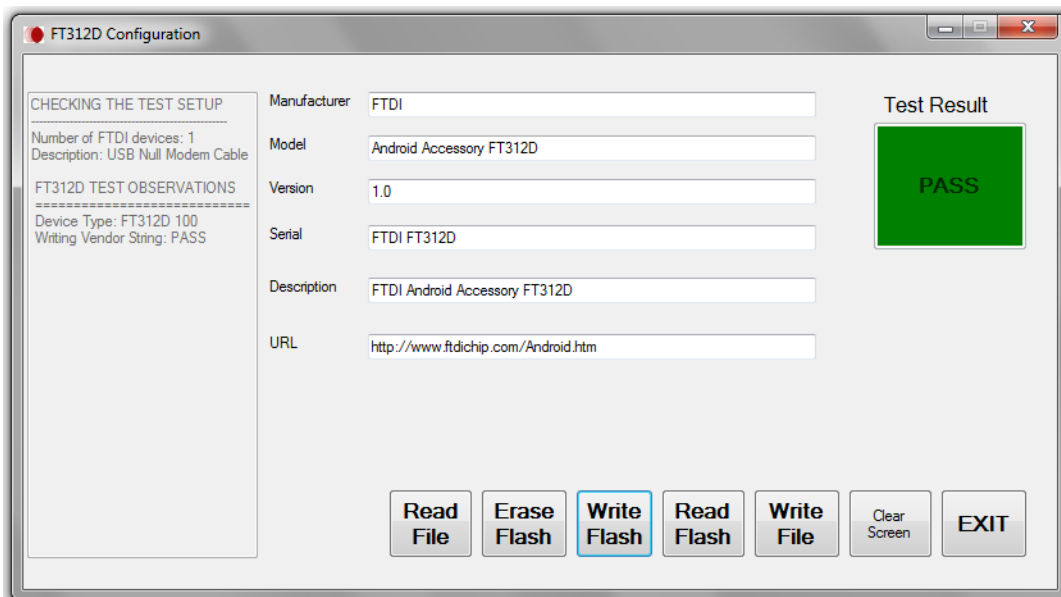

Figure 3.3: Write Flash result - PASS

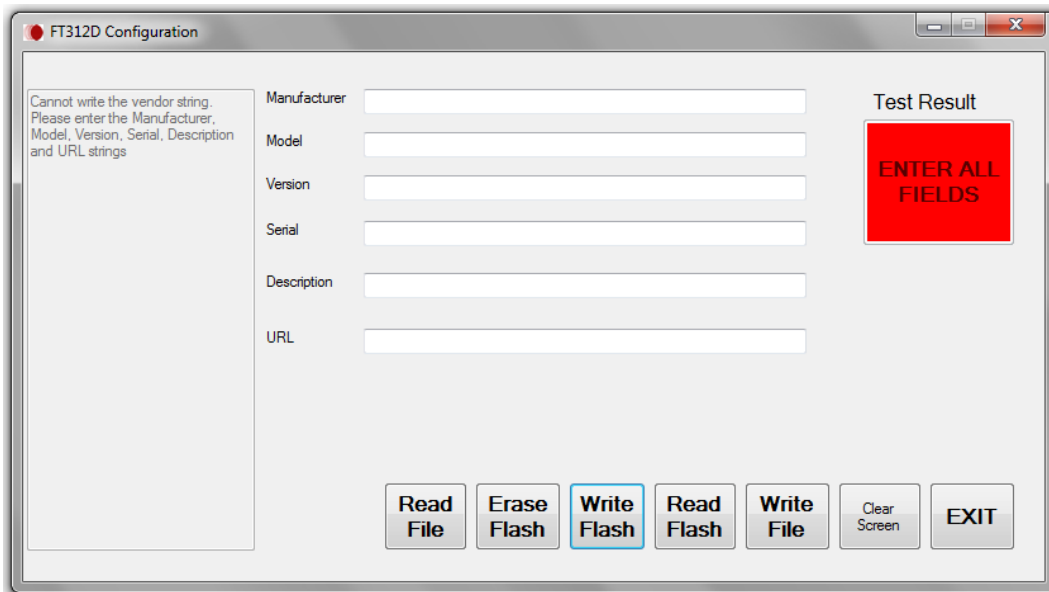

Figure 3.4: Write Flash result - FAIL

Read Flash

Read Flash will read the descriptor string values previously stored in FT312D and display them in the GUI. A device that has not been written with user specified descriptor string or has been erased will return blank values in the GUI.

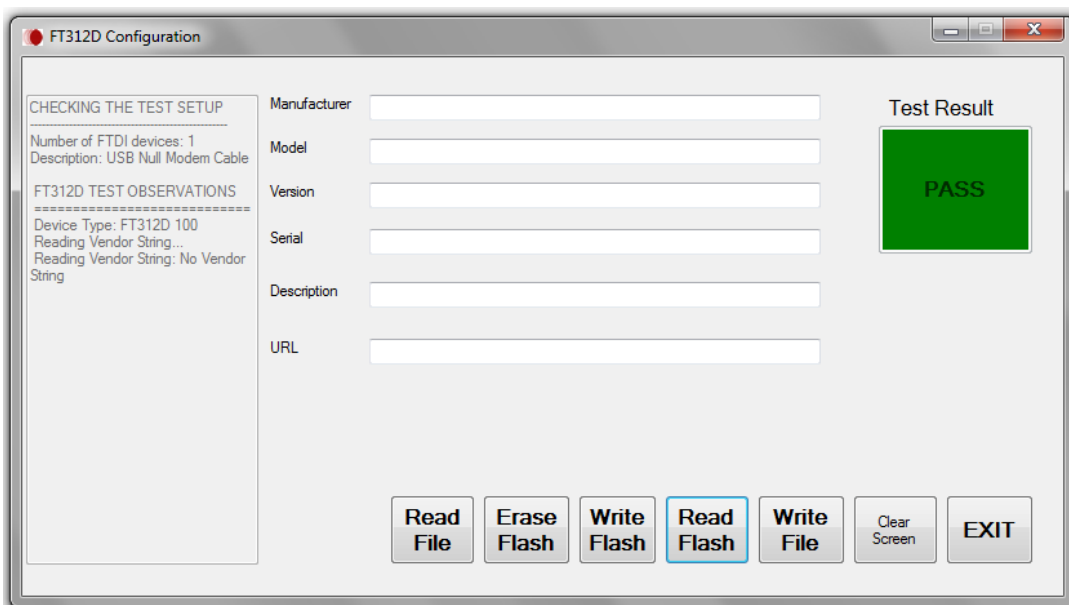

Figure 3.5: Read Flash with default descriptor string

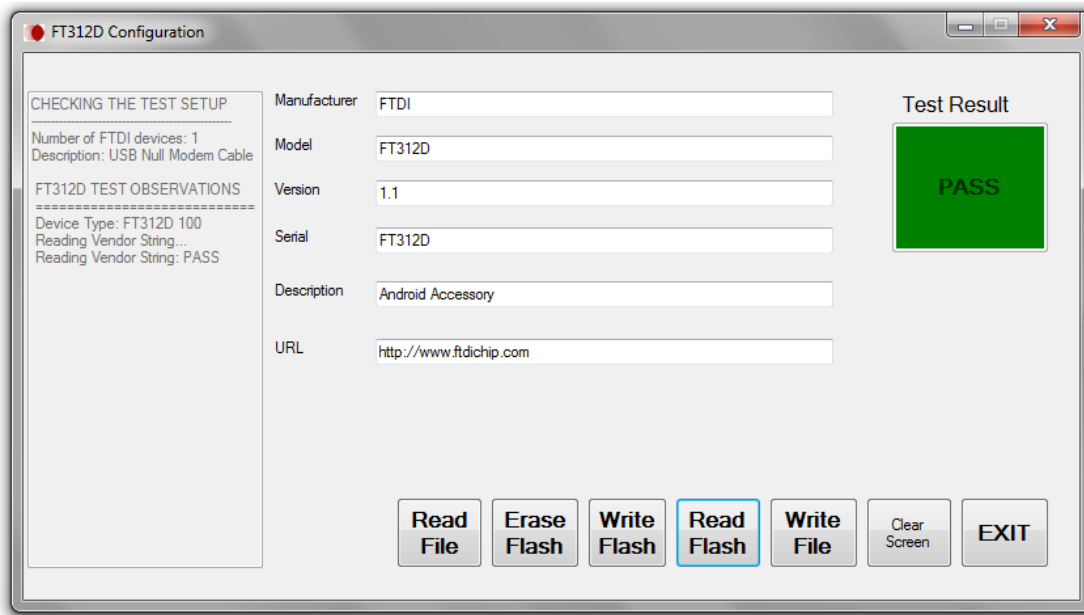

Figure 3.6: Read Flash with user defined descriptor string

Write File

Write File will store the values displayed in the GUI to the FT312DConfiguration.xml file.

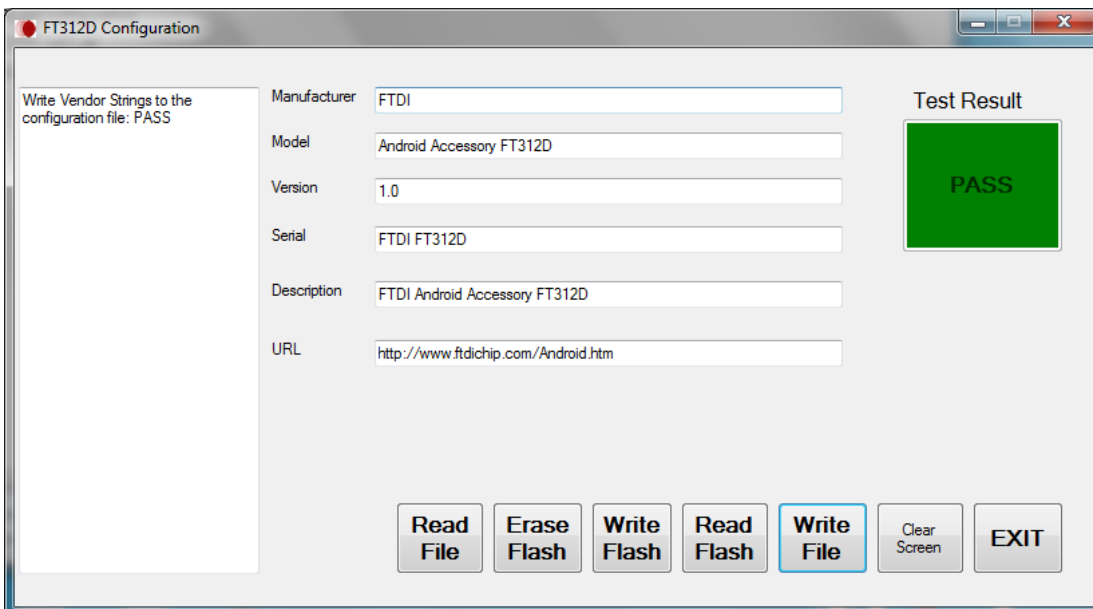

Figure 3.7: Write File

Clear Screen

Clear screen will reset the display to blank fields.

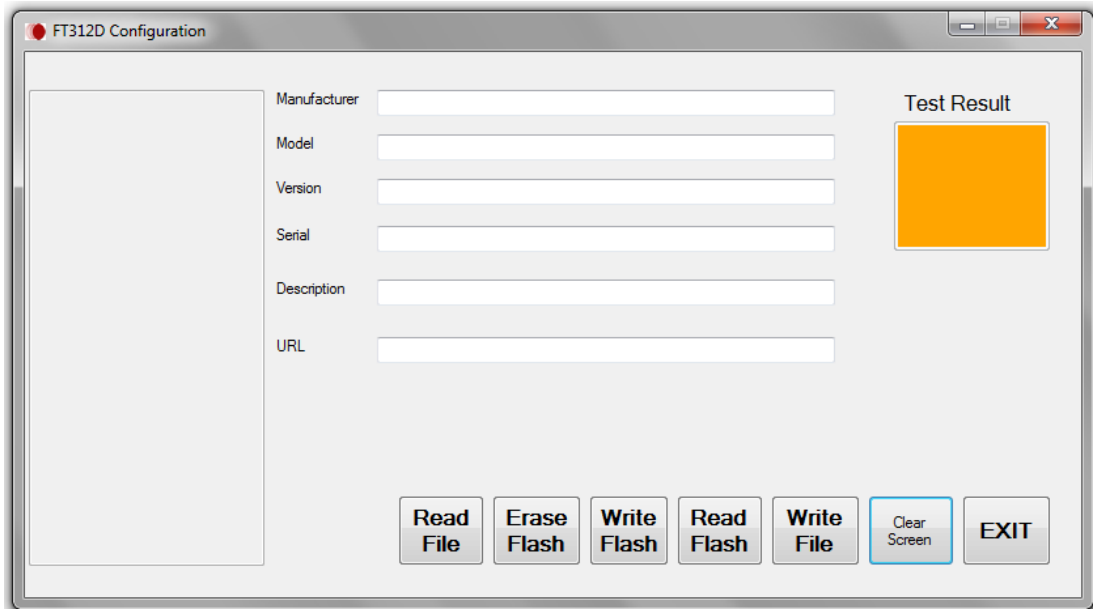

Figure 3.8: Clear Screen

EXIT

The application may be closed by selecting EXIT.

Note:

-
- **The Erase Flash, Write Flash and Read Flash button in the utility is functional only when the FT312D is connected.**
- **The Read File, Write File, Clear Screen and EXIT button in the utility is functional with the FT312D connected or not.**

3.1 Test Setup Errors

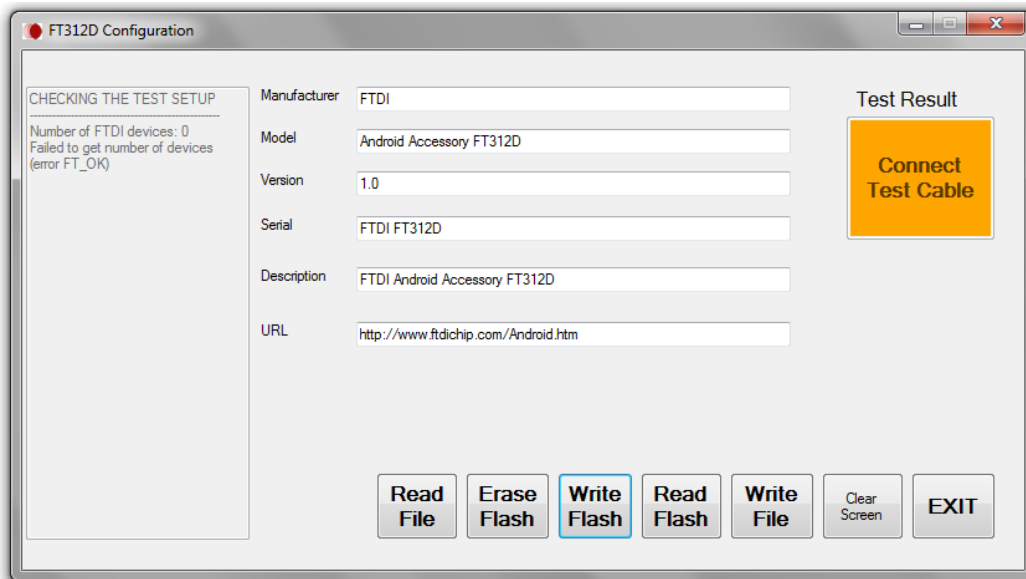

Figure 3.9: FTDI USB to USB Null Modem cable not connected to test PC

The error message in [Figure 3.9](#) appears when the USB to USB Null Modem cable is not connected to the test PC.

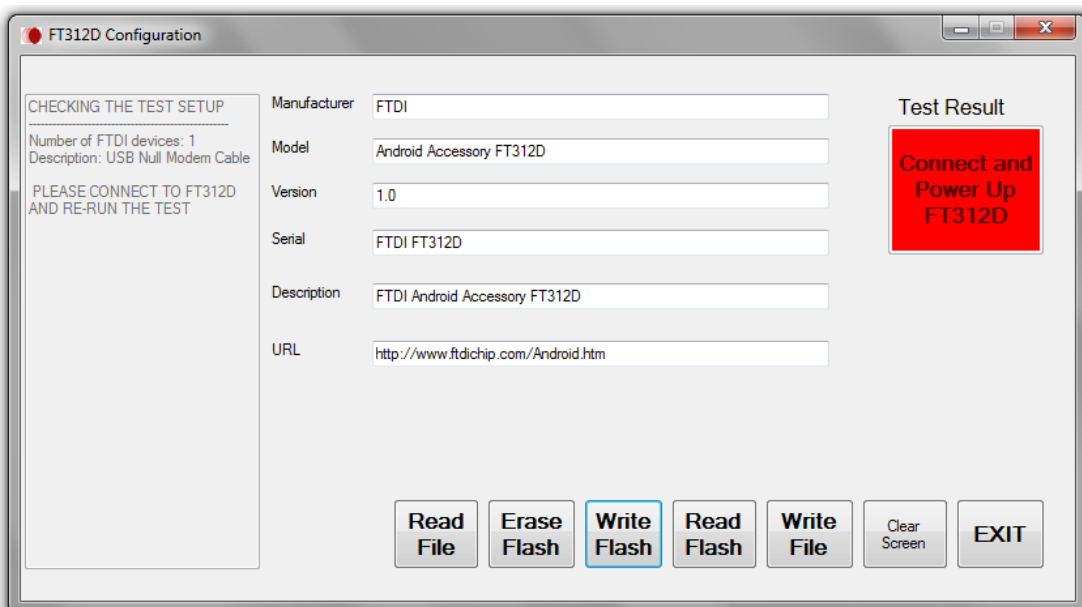

Figure 3.10: FTDI USB to USB Null Modem cable not connected to FT312D

The error message in [Figure 3.10](#) appears when the Null Modem cable is not connected to the FT312D or the FT312D is not powered up.

3.2 User Defined descriptor size

The size of the descriptor strings are listed below

Descriptor String	Maximum string size allowed
Manufacturer	63
Model	31
Version	7
Serial	31
URL	127
Description	95

Table 3.1: Descriptor string size

4 FTDI Chip Contact Information

Head Office – Glasgow, UK

Unit 1, 2 Seaward Place, Centurion Business Park
Glasgow G41 1HH
United Kingdom
Tel: +44 (0) 141 429 2777
Fax: +44 (0) 141 429 2758

E-mail (Sales) sales1@ftdichip.com
E-mail (Support) support1@ftdichip.com
E-mail (General Enquiries) admin1@ftdichip.com

E-mail (General Enquiries) tw.admin1@ftdichip.com

Branch Office – Tigard, Oregon, USA

7130 SW Fir Loop
Tigard, OR 97223
USA
Tel: +1 (503) 547 0988
Fax: +1 (503) 547 0987

E-Mail (Sales) us.sales@ftdichip.com
E-Mail (Support) us.support@ftdichip.com
E-Mail (General Enquiries) us.admin@ftdichip.com

Branch Office – Taipei, Taiwan

2F, No. 516, Sec. 1, NeiHu Road
Taipei 114
Taiwan, R.O.C.
Tel: +886 (0) 2 8791 3570
Fax: +886 (0) 2 8791 3576

E-mail (Sales) tw.sales1@ftdichip.com
E-mail (Support) tw.support1@ftdichip.com

Branch Office – Shanghai, China

Room 1103, No. 666 West Huaihai Road,
Shanghai, 200052
China
Tel: +86 21 62351596
Fax: +86 21 62351595

E-mail (Sales) cn.sales@ftdichip.com
E-mail (Support) cn.support@ftdichip.com
E-mail (General Enquiries) cn.admin@ftdichip.com

Web Site

<http://ftdichip.com>

System and equipment manufacturers and designers are responsible to ensure that their systems, and any Future Technology Devices International Ltd (FTDI) devices incorporated in their systems, meet all applicable safety, regulatory and system-level performance requirements. All application-related information in this document (including application descriptions, suggested FTDI devices and other materials) is provided for reference only. While FTDI has taken care to assure it is accurate, this information is subject to customer confirmation, and FTDI disclaims all liability for system designs and for any applications assistance provided by FTDI. Use of FTDI devices in life support and/or safety applications is entirely at the user's risk, and the user agrees to defend, indemnify and hold FTDI harmless from any and all damages, claims, suits or expense resulting from such use. This document is subject to change without notice. No freedom to use patents or other intellectual property rights is implied by the publication of this document. Neither the whole nor any part of the information contained in, or the product described in this document, may be adapted or reproduced in any material or electronic form without the prior written consent of the copyright holder. Future Technology Devices International Ltd, Unit 1, 2 Seaward Place, Centurion Business Park, Glasgow G41 1HH, United Kingdom. Scotland Registered Company Number: SC136640

Appendix A – References

Document References

[FT311D Development Module datasheet](#)

[FT312D Development Module datasheet](#)

[FT311D Development Module datasheet](#)

[FT311 GPIO Board datasheet](#)

Acronyms and Abbreviations

Terms	Description
FT312D	FTDI USB Android Accessory
PC	Personal Computer
RXD	Receive
TXD	Transmit Asynchronous Data output
UART	Universal asynchronous receiver/transmitter
USB	Universal Serial Bus
USB-IF	USB Implementers Forum

Appendix B – List of Tables & Figures

List of Tables

Table 3.1: Descriptor string size	11
---	----

List of Figures

Figure 1.1: Block diagram of FT312D Configuration setup	2
Figure 2.1: Completed FT312D Test Setup	4
Figure 3.1: FT312D Configuration Utility	5
Figure 3.2: Erase Flash	6
Figure 3.3: Write Flash result - PASS	6
Figure 3.4: Write Flash result - FAIL	7
Figure 3.5: Read Flash with default descriptor string	7
Figure 3.6: Read Flash with user defined descriptor string	8
Figure 3.7: Write File	8
Figure 3.8: Clear Screen	9
Figure 3.9: FTDI USB to USB Null Modem cable not connected to test PC	10
Figure 3.10: FTDI USB to USB Null Modem cable not connected to FT312D	10

Appendix C – Revision History

Document Title: AN_236 User Guide for FT312D Configuration Utility
Document Reference No.: FT_000821
Clearance No.: FTDI# 338
Product Page: <http://www.ftdichip.com/FTProducts.htm>
Document Feedback: [Send Feedback](#)

Revision	Changes	Date
1.0	Initial Release	2013-04-25